

## **Single wheel drives for wheel slip control**

Stephan Kaspar<sup>1</sup>, Dr. Ralf Stroph<sup>1</sup>, Dr. Alfred Pruckner<sup>1</sup>, Prof.-Dr. Sören Hohmann<sup>2</sup>

<sup>1</sup>*BMW Research and Technology, Hanauer Str.46, 80992 Munich, Germany, stephan.sk.kaspar@bmw.de*

<sup>2</sup>*Institute of Control Systems, KIT, Wilhelm-Jordan-Weg, 76131 Karlsruhe, Germany, soeren.hohmann@kit.edu*

---

### **Abstract**

Ever-increasing electrification of the drive train offers new possibilities for the power train layouts as well as for vehicle dynamics control. For a single-wheel driven electric vehicle, one should utilize the advantages of the electric engines compared to conventional components. Within this contribution, an optimized arrangement regarding installation space of the drive train with single rear wheel drive was investigated. The electric motors were used for acceleration and deceleration, hence regenerative braking. Often, for brake situations with excessive wheel slip, electric engines are switched off and conventional components as the hydraulic wheel brakes are used to control the wheel speed. A control scheme for a rear-wheel driven electric vehicle with single wheel drives is presented, where only the rear engines and no friction brakes are used for all driving and braking torques. The effectiveness of the proposed control scheme has been proven in real vehicle tests for acceleration as well as for braking situations on low friction coefficient surface (snow).

*Keywords: traction control, regenerative braking, electric vehicle, vehicle performance*

---

### **1 Introduction**

The design of electric vehicles, especially the drive train layout, must utilize the obtained degrees of freedom given by electrification instead of only replacing combustion engines with electric machines to succeed [1], [2] and [3]. Common concepts for electric vehicles are either equipped with a centrally arranged electric motor or are carried out as de-centralised in-wheel multi motor concepts. Drive train layouts with centralised single engines cannot provide additional installation space due to common arrangement of gears, differential, axes and drive shafts. However, making use of de-centralised drive train design, one space-saving arrangement of high-voltage batteries, electric engines and

gears in the well protected rear end of the vehicle has been developed by the department for research and technology of the BMW Group. Moreover, the common well-known disadvantages of in wheel-drives as shortage of power, added unsprung masses or the lack of a suitable gear ratio have been overcome. A system overview is given in figure 1 [3]. The engines are attached to the vehicle body, while the gears are also serving as chassis. For optimized package utilization, the friction brakes of the rear wheels are neglected. Hence, the electric engines have been designed to perform all braking forces. Also, excessive wheel slip has to be controlled only by manipulation of the electric engines' torques. Some vehicle data is given in table 1.

Table1: Technical data of the test vehicle

Nominal power	2 x 60 kW
Peak power	2 x 120 kW
Vehicle mass	1700 kg
Transmission	Single rear wheel drive
Maximum wheel torque	2 x 1400 Nm

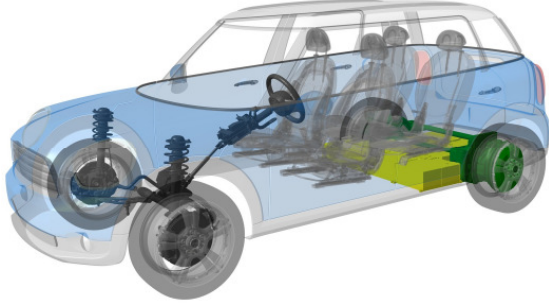

Figure 1: Drive train layout of the test vehicle

## 2 State of the Art

As there are no friction brakes at the vehicles rear wheels, all driving states including anti-lock (ABS) and traction control (ASC) intervention must be performed by the electric engines. Furthermore, in order to increase the possible driving range, the recuperation potential has to be maximised. For the investigated drive train layout, this results in braking the vehicle as much as possible at its rear wheels, which is a challenge with respect to vehicle driving stability. A lot of research work deals with the combination of electric and hydraulic braking. Most of the time, focus is on optimization of the wheel torque distribution and the corresponding torque proportioning for over actuated systems [4], [5] and [6]. Further investigation is also made in blending functions between hydraulic and electric braking torques [7] and [8]. Even though the electric engines can deliver the requested torque very fast and precisely, electric engines are generally switched off whenever an ABS situation is detected [9]. Sakai and Hori depicted the advantages when using electric engines for anti skid control at combined hydraulic/electric braking for real vehicle tests in [10]. Regenerative braking at the vehicle's rear axis even for anti lock braking situations have been discussed in [11]. Results are carried out by simulation, and only braking has been investigated. Within this contribution, the electric motors are used for all drive and brake situations including antilock braking (ABS) and acceleration slip control (ASC). All results are

carried out by real vehicle tests on low friction coefficient surface (snow). The overall goal was to eliminate excessive wheel slip and thereby keeping the vehicle stable.

## 3 Proposed Control Scheme

An overview of the proposed control scheme is given in figure 2. The driver request via the drive pedal (DP) and the brake pedal (BP) is evaluated in the block *Longitudinal Feed Forward Control* (LFFC) where an equally distributed torque is determined according to the desired acceleration, which is used as feed forward (FF) value. For this preliminary research of the control concept, the yaw control (YC) was disabled. The block *Wheel Slip Limits* (WSL) calculates wheel speed threshold limits for ABS and ASC interventions. A wheel speed controller ( $\omega$ CRL/ $\omega$ CRR) for each side subsequently prevents given speed limits from being violated and modifies wheel torque control (CTRL) commands if necessary. Finally, the block *Zero Moment Impact Damping* (ZMID) is used to smoothen changes of sign of the wheel's torques for comfort reasons. The mentioned functions will be explained in more detail hereafter.

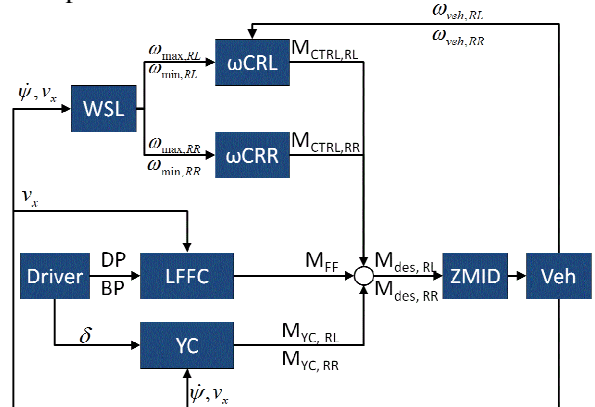

Figure 2: Proposed Control Scheme

### 3.1 Longitudinal Feed Forward Control (LFFC)

Dependent on the angles of drive- and brake pedal ( $DP, BP$ ) and the actual vehicle velocity ( $v_x$ ), the needed overall longitudinal force to fulfil the driver's demand on acceleration is evaluated and equally converted into the wheel torque  $M_{FF}$ , which is equally distributed to the right and left wheel.

### 3.2 Wheel Speed Limits (WSL)

For suitable ABS or ASC intervention, reasonable wheel speed limits for each side need to be given.

Therefore, the wheel speeds

$$\omega_{0,RR} = \frac{v_x}{R_{dyn}} + \frac{rtw \cdot \dot{\psi}}{2 \cdot R_{dyn}} \quad (1)$$

$$\omega_{0,RL} = \frac{v_x}{R_{dyn}} - \frac{rtw \cdot \dot{\psi}}{2 \cdot R_{dyn}} \quad (2)$$

of freely rolling wheels with dynamic tyre radius  $R_{dyn}$ , rear track width  $rtw$  and yaw rate  $\dot{\psi}$  are calculated. Dependent on  $v_x$ , wheel slip limits  $\lambda_{ASC}$  and  $\lambda_{ABS}$  are evaluated which are used to calculate the vehicle speed limits

$$\omega_{max,RL} = (1 + \lambda_{ASC}) \cdot \omega_{0,RL} \quad (3)$$

$$\omega_{max,RR} = (1 + \lambda_{ASC}) \cdot \omega_{0,RR} \quad (4)$$

$$\omega_{min,RL} = (1 - \lambda_{ABS}) \cdot \omega_{0,RL} \quad (5)$$

$$\omega_{min,RR} = (1 - \lambda_{ABS}) \cdot \omega_{0,RR} \quad (6)$$

### 3.3 Wheel Speed Controller Left and Right ( $\omega_{CRL}$ , $\omega_{CRR}$ )

The wheel speed controllers for the left and the right side are equally composed, hence, indices RL and RR are neglected in this section.

Each wheel speed controller consists of two parts: a PI-controller for ASC interventions and an independent PI-controller for ABS interventions. In that way, parameters for ASC and ABS controllers can be chosen independently, and by this more application options are given.

The controller should only interfere once a wheel speed limit is breached, therefore, the control errors can be calculated as

$$\Delta\omega_{ASC} = \min(0, \omega_{max} - \omega_{veh}) \quad (7)$$

$$\Delta\omega_{ABS} = \max(0, \omega_{min} - \omega_{veh}) \quad (8)$$

with the actual wheel speed  $\omega_{veh}$ .

### 3.4 Zero Moment Impact Damping (ZMID)

As mentioned above, the electric engines are used for acceleration and braking, with their main advantage of fast torque response with very precise accuracy of torque and measured wheel speed. The flipside is that high torque gradients can harm the gears when changing their sign as the backlash of toothed wheel can lead to impacts when crossing the zero-moment. Additionally, severe edge changes of the gears tend to result in inconvenient noise and vibrations.

The block *Zero Moment impact Damping* is used to avoid this. It consists of a torque-variable time-discrete integrator with variable limited

gain. Its effect is shown in figure 3, where the actual torque  $M_{dp}$  follows the desired torque  $M_{des}$ . For high and low torques, the permitted torque rate is very large, hence there is almost no time delay (one time-step because of the time-discrete integrator). Whenever the torque approaches zero the torque gradient is limited so that only very small impact on the gear wheels occurs whenever the torque command changes sign. Obviously, the dynamic performance is declined by the ZMID function, but it is absolutely necessary for hardware protection and comfort reasons. Hence, a good trade-off between dynamic response and smooth torque course had to be found.

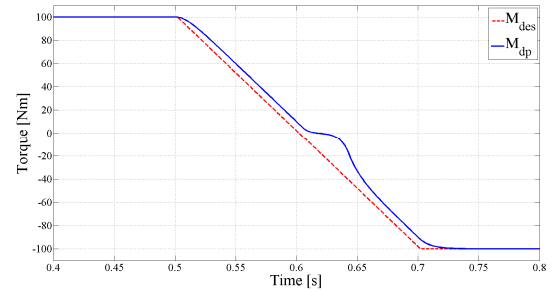

Figure 3: ZMID function

### 3.5 Yaw Control (YC)

The yaw controller consists of a model-based feed forward part and a feedback controller. It is disabled for investigations concerning this paper. Hence, the controller has no influence on simulation results and does not need to be specified in detail.

## 4 Road Test Results

All test results were carried out at the BMW proving ground in Arjeplog/Schweden on snowy surface with a low friction coefficient between 0.3 and 0.4. To show the performance of ASC control, the manoeuvre *Straight Line Acceleration* with fully applied drive pedal was chosen. The advantages of single wheel drives are show for *Straight Line Braking on Mue Split*. The manoeuvre *Acceleration While Cornering* revealed the improvements with respect to vehicle stability.

### 4.1 Straight Line Acceleration

The initial condition for straight line acceleration is slow straight driving with  $v_x \approx 15\text{kph}$  on snowy road with a friction coefficient  $\mu$  of about 0.3-0.4. At  $t = 1\text{s}$ , full throttle was applied. No brakes were used during the whole manoeuvre, the steering wheel angle was held at its zero position.

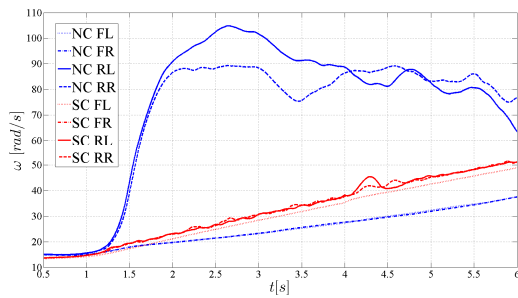

Figure 4: Wheel speeds for SLA

The resulting wheel speeds can be seen in figure 4. As no traction or braking forces are applied to the front wheels (index FR, FL), they can be used as reference value for freely rolling wheels. Without slip control (NC), the rear wheels (RL,RR) are strongly accelerated as the friction coefficient is insufficient. Due to system limitations, after 500ms, full throttle has to be released and was held between 75 and 85 per cent. The slip controller (SC) is able to limit the wheel slip to a desired value (figure 5); at the beginning of the manoeuvre, vehicle speed is low, therefore 10 per cent wheel slip is allowed, which is linearly decreased to 5 per cent over increasing speed for stability reasons.

Without slip control, wheel slip values raise up to 0.8, which indicate very unstable driving behaviour as there is almost no lateral force potential left. The slip controller succeeds in limiting the wheel slip to desired values, even without overshoot at the beginning. The average deviation from the desired slip value is fairly low with only 2 per cent, with one exception: at 4,5s, the slip value of the rear left wheel raises up to 15 per cent which can be referred to unsteadiness of the friction value. The overshoot is immediately compensated without oscillations.

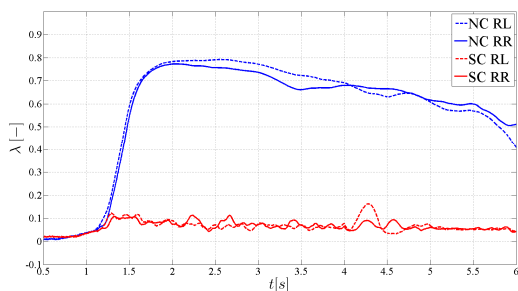

Figure 5: Wheel slip for SLA

Even though the wheel slip limitations are designed for vehicle stability, the longitudinal driving performance is also enhanced: without control (NC), the achieved longitudinal acceleration is around 1.0-1.5  $m/s^2$  (figure 6).

With slip control, the longitudinal acceleration is higher with smoother course. At the beginning of the manoeuvre, 10 per cent wheel slip is allowed which results in 2.5  $m/s^2$  acceleration. With decreasing wheel slip limit for higher vehicle speeds, the achievable acceleration is also reduced ( $a_x = 2.0 m/s^2$  for  $\lambda = 5\%$ ). Nevertheless, for safety reasons and lateral stability, slip limitations should not be raised.

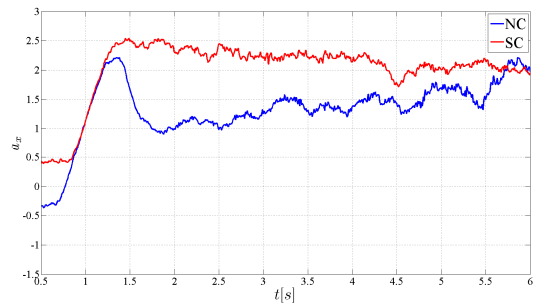

Figure 6: Longitudinal acceleration for SLA

## 4.2 Straight Line Braking – Mue Split

Straight line braking results corresponded to the results found for straight line acceleration: wheel slip limits were satisfied by the controller which made the vehicle more stable and raised achievable acceleration values at the same time. Therefore, straight line braking with different friction values left/right is chosen to show the performance during braking: the right wheels are braked on snowy road surface with low friction coefficient of 0.4 while the left wheels are running on heated asphalt with  $\mu = 1$ . One main target for electric vehicles is the maximisation of recuperative braking without making use of the friction brakes to enlarge the possible cruising range. Therefore, braking was only applied on the rear axis through the electric engines at  $t = 3.0s$ .

Resulting wheel speeds without (NC) and with (SC) slip control are given in figure 7. Note that without control at  $t = 3.95s$  the wheel speed on low friction side is already zero; as braking forces are applied through the electric engines and there's no other control mechanism, the wheel starts to spin backwards. At the end of the manoeuvre the wheel speed is  $\omega_{RR} = -60 rad/s$ , which equals around -70 km/h.

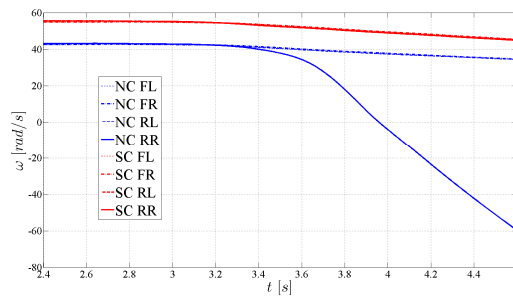

Figure 7: Wheel speeds for SLBMS

Consequent wheel slip values prove the performance of the single wheel control (figure 8): The high-friction side (RR) is stable on both sides as braking forces are not high enough to violate the adhesion limits. Without controls, the wheel slip rises excessively. The slip controller instead manages to limit the wheel slip to the desired value of 2 per cent with very small deviations of  $\pm 0.4$  per cent.

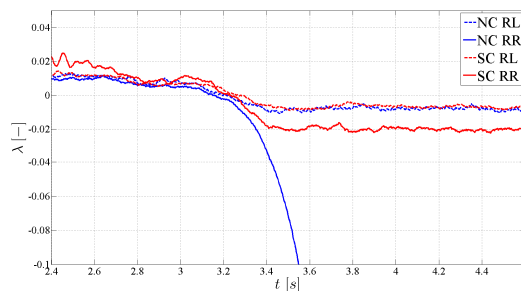

Figure 8: Wheel slip for SLBMS

Nevertheless, more deceleration is achieved by the slip controller (figure 9). The uncontrolled vehicle deceleration is  $a_x = -1.6 \text{ m/s}^2$  once the right rear wheel slips, while the deceleration with control is  $a_x = -2.2 \text{ m/s}^2$ .

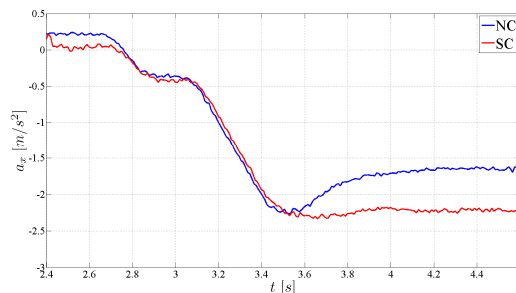

Figure 9: Longitudinal acceleration for SLBMS

The advantage of the single wheel drives becomes apparent when examining the wheel torques (figure 10). Only braking torque on the low friction side is limited as the controllers act independently on each other. If the car was driven by only one single engine, regenerative

braking torque on the high friction side would be limited to the low friction value because of the differential gear, which results in lower deceleration.

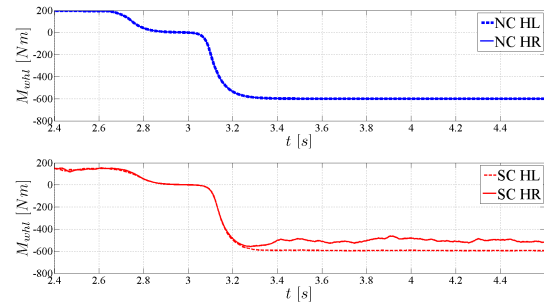

Figure 10: Wheel torques for SLBMS

### 4.3 Acceleration While Cornering

Stability problems without wheel slip control become even more obvious when combining longitudinal and lateral demands. To demonstrate the effectiveness of the applied slip controller, the manoeuvre *Acceleration While Cornering* was chosen. The vehicle starts steady-state cornering at low speed on a circle with radius of 50 meters and snowy low friction surface. At  $t = 1.0\text{s}$ , full throttle is applied and the steering wheel angle is held constant. The goal is to achieve maximum acceleration while preventing the vehicle from spinning out.

Without slip control, the rear wheels speed up (as for straight line acceleration, figure 11), which lead to excessive wheel slip (figure 12). For such high slip rates, there is no lateral force potential on the rear wheels left, so that the yaw rate increases immediately (figure 15) which means the vehicle spins out and becomes unstable.

The slip controller limits wheel slip to the adjusted value of 5 per cent. The overshoot at the beginning of the acceleration until the controller has settled the wheel speed to its steady-state value is higher for the inner wheel as its wheel load is less and so the same wheel torques lead to higher wheel slip. Therefore, during acceleration, torque of the inner wheel needs to be lower, as performed by the slip controller (figure 14).

The chosen wheel slip limit of 5 per cent is not optimised for longitudinal acceleration; higher slip values lead to higher acceleration (figure 13). But the higher the wheel slip limits are chosen, the more lateral force potential is lost and the higher is the risk of a spinout. Therefore, the used limits are a good compromise which lead to satisfying acceleration and stable vehicle handling (stable

and slight increase of the yaw rate due to ascending vehicle speed, figure 15).

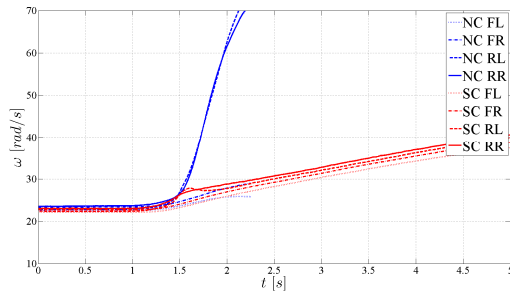

Figure 11: Wheel speeds for AWC

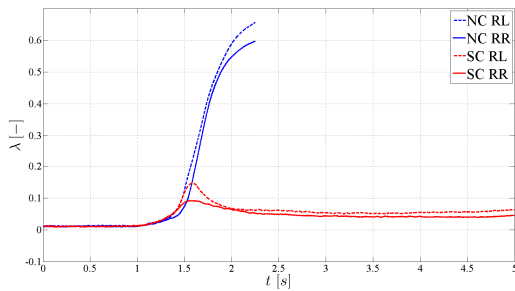

Figure 12: wheel slip for AWC

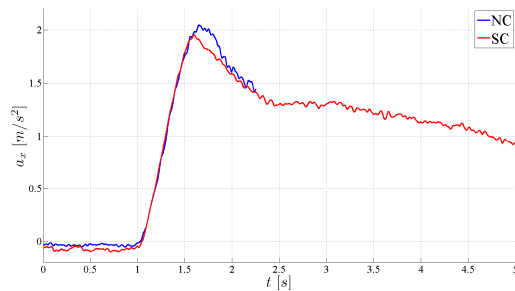

Figure 13: longitudinal acceleration for AWC

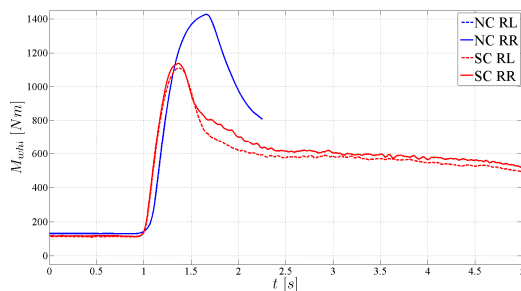

Figure 14: wheel torques for AWC

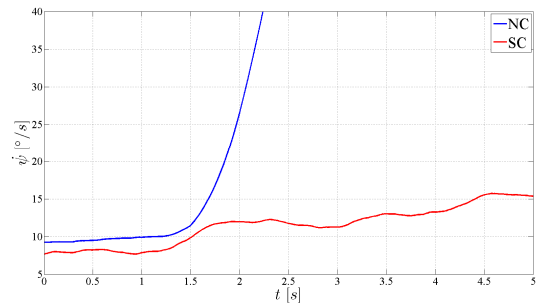

Figure 15: yaw rate for AWC

## 5 Conclusion and Outlook

Within this contribution, a drive train layout for future vehicle concepts is presented. The corresponding control structure for wheel force distribution, ABS and ASC intervention is described. The effectiveness of the wheel slip controller is evaluated through real vehicle tests. For acceleration as well as braking manoeuvres chosen wheel slip limits could be observed with small deviations. All wheel torques are only applied by the electric engines, no hydraulic brakes or clutches are used.

Future work will investigate the interaction of yaw control and wheel slip controllers for all friction values and driving situations. For the manoeuvre *Acceleration While Cornering*, different wheel loads led to higher wheel torques on the outer side; This can result in over steering and the risk of a spin out as the shift of torque towards the outer wheel means an additional in-turning yaw moment. In future work, the yaw controller is used to prevent this and use the torque distribution to manipulate the yaw motion of the vehicle in a desired way.

## References

- [1] J.-W. Biermann; B. Hartmann: *Maßgeschneiderte Fahrzeugkonzepte für Elektroantriebe*. DRIVE-E-Akademie, Erlangen, 10.03.2010
- [2] M. Anderson; D. Harty: *Unsprung Mass with In-Wheel Motors – Myths and Realities*. 10th International Symposium on Advanced Vehicle Control (AVEC 2010), Loughborough, UK, 2010
- [3] A. Pruckner, *Potenziale eines radnahen Elektroantriebs zur Gestaltung neuer Antriebs- und Fahrzeugarchitekturen*, VDI-Fachkonferenz: Berechnung und Erprobung bei alternativen Antrieben, Baden-Baden, 2011

- [4] P. Reinold; A. Trächter: *Multi-objective Optimization for the Determination of the Actuating Variables of the Horizontal Dynamics of an Electric Vehicle with single-wheel Chassis Actuators*, Autoref 2011, VDI-Berichte 2135, Baden-Baden, VDI Verlag GmbH, ISBN 978-3-18-092135-8, 2011
- [5] C. Knobel et. Al., *OPTIMIZED FORCE ALLOCATION - A General Approach to Control and to Investigate the Motion of Over-Actuated Vehicles*, 4<sup>th</sup> IFAC Symposium on Mechatronic Systems, Heidelberg, 2006
- [6] J. Krueger et. Al., *Control Allocation für Straßenfahrzeuge – ein systemunabhängiger Ansatz eines integrierten Fahrdynamikreglers*, 19. Aachener Kolloquium Fahrzeug- und Motorentechnik, Aachen, 2010
- [7] M. Meyer et. Al., *Brake System for electric vehicles – challenges and opportunities*, chassis.tech 2011, Munich, Springer Automotive Media, 2011
- [8] O. Hayes et. Al., *Porsche 911 GT3 R Hybrid – recuperation brake system*, chassis.tech 2011, Munich, Springer Automotive Media, 2011.
- [9] M. Rosenberger et. Al., *Integration der elektrischen Antriebsmotoren in die ABS-Regelung*, 2. Automobiltechnisches Kolloquium, Garching, 2011
- [10] S-I. Sakai; Y. Hori, *Advantage of Electric Motor for Anti-Skid Control of Electric Vehicle*, European power electronics and drives Journal Volume 11-4, 2001, 26-32
- [11] M. Teitzer et Al., *Simulation of an anti-lock braking system with electric motors during regenerative braking in powerful BEV's*, chassis.tech, Munich, 2010



Dr. Ralf Stroph is development engineer in the team Active Chassis Control within the BMW Group Research and Technology. He studied Electrical Engineering at the University of Applied Science of Osnabrück where he graduated in 1995. He completed his DPhil thesis at the University of York in 1999.



Dr. Alfred Pruckner is responsible for the team “Active Chassis Control” within BMW Group Research and Technology in Munich. He graduated in mechanical engineering at the Technical University of Vienna in 1995 and completed his PhD thesis at the RWTH Aachen in 2002.



Prof. Dr. Sören Hohmann is Full Professor with the Institute of Control Systems within the Karlsruhe Institute of Technology. He graduated 1997 in Electrical Engineering and completed his PhD thesis in 2002. Initially working for the BMW Group, leading the development of active safety systems, he became head of the Institute of Control Systems in Karlsruhe in 2010.

## Authors



Stephan Kaspar is PhD student with the team Active Chassis Control within the BMW Group Research and Technology. He studied mechanical engineering at the Technical University of Munich where he finished his diploma in 2010.